

## BLOK - ADCA - RIFOX - VYC LAUHTENPOISTIMET

Erilaiset lauhteenpoistinmallit takaavat toiminnan erilaisissa käyttökohteissa, ja niiden käyttö vähentää putkistoissa tapahtuvia nesteiden aiheuttamia paineiskuja. Oikein valittu lauhteenpoistin takaa muiden putkiston laitteiden moitteettoman toiminnan ja säästää energiaa.

Termiset lauhteenpoistimet  
(kapselimalli)  
Sivu 2

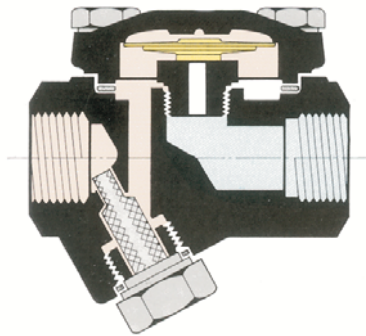

Termiset lauhteenpoistimet  
(bimetalli)  
Sivu 3

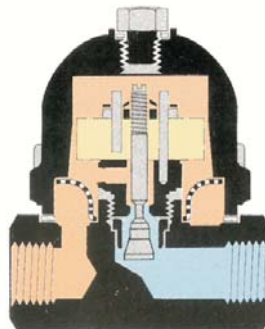

Termodynaamiset  
lauhteenpoistimet  
Sivu 8

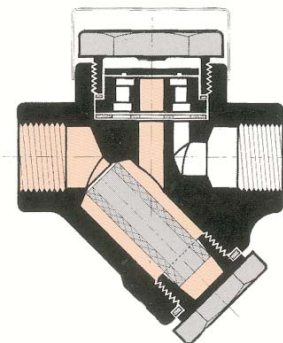

Uimurilauhteenpoistimet  
Sivu 4-7

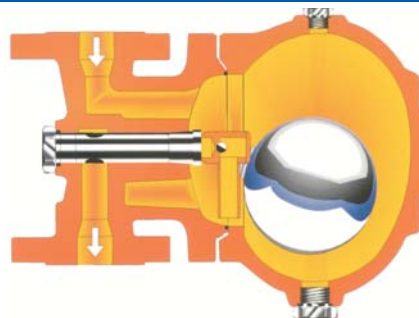

## MALLISARJA TH

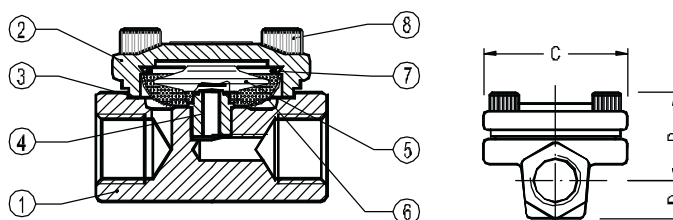

### MALLI TH21 Teräs Malli TH21 SS Ruost.teräs

käyttöpaine 21 bar / 250°  
suunn.paine 21 bar / 300°

TH21 Teräs 1/2" / DN15  
TH21SS 1/2" -1" / DN15-25  
**PN25**

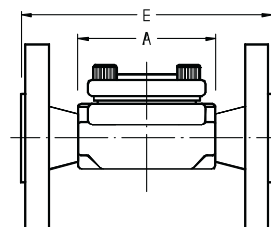

TH 21 - MITAT (mm)

KOKO	KIERTEIN				D	DIN LAIPOIN		
	A	B	C	PAINO		E	PAINO	
DN								
1/2"	70	35	60	15	0,7	130	2,2	

TH 21 SS - MITAT (mm)

KOKO	KIERTEIN				D	DIN LAIPOIN		
	A	B	C	PAINO		E	PAINO	
DN								
1/2"	80	35	17	1,8	150	3,3		
3/4"	80	37	20	1,9	150	4,1		
1"	80	40	23	2,1	160	5,1		

G - ISO 2852, DIN 32676 tai BS 4825.

VIRTAUSMÄÄRÄ Kg/h

MALLI	KOKO	PAINE-ERO (bar)														
		0.2	0.3	0.5	1	1.5	2	3	4	6	8	10	13	15	20	22
TH 21	1/2"	70	120	140	255	330	385	455	510	600	670	700	720	750	775	795
TH21 LC	1/2"	45	55	70	95	125	135	180	200	270	315	330	360	370	405	415

### Malli TH35Y Teräs TH35Y/2 Teräs / 2:lla kapselilla TH35Y/3 Teräs / 3:lla kapselilla TH35Y/4 Teräs / 4:lla kapselilla

Käyttöpaine 22 bar / 250°  
Suunn.paine 22 bar / 300°  
PN40

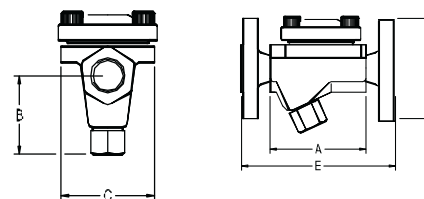
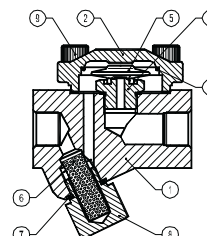

MITAT (mm)

KOKO	A	B	C	∅	PAINO
DN					
40	230	150	101	140	11
50	230	165	108	140	12.5

MITAT (mm)

KOKO	KIERTEIN				D	DIN LAIPAT		
	A	B	C	PAINO		E	PAINO	
DN								
1/2"	95	52	76	96	1,8	150	3,4	
3/4"	95	52	76	105	1,7	150	4,1	
1"	95	52	76	115	1,6	160	4,5	

VIRTAUSMÄÄRÄ Kg/h

MALLI	KOKO	PAINE-ERO (bar)														
		0.2	0.3	0.5	1	1.5	2	3	4	6	8	10	13	15	20	22
TH35Y	1/2" - 1"	70	120	140	255	330	385	455	510	600	670	700	720	750	775	795
TH35YLC	1/2" - 1"	45	55	70	95	125	135	180	200	270	315	330	360	370	405	415

VIRTAUSMÄÄRÄ Kg/h

MALLI	KOKO	PAINE-ERO (bar)						
		0.5	1	2	5	10	15	22
TH35 / 4	40-50	420	760	1300	2250	2900	3200	3350

## MALLISARJA KS - KSV

Käyttöpaine 0 – 17 bar / 400°C  
suunn.paine PN40  
Teräs C22.8 / RST-osat  
Kiertein 1/2", 3/4"  
Laipoin DN15, DN20/PN40

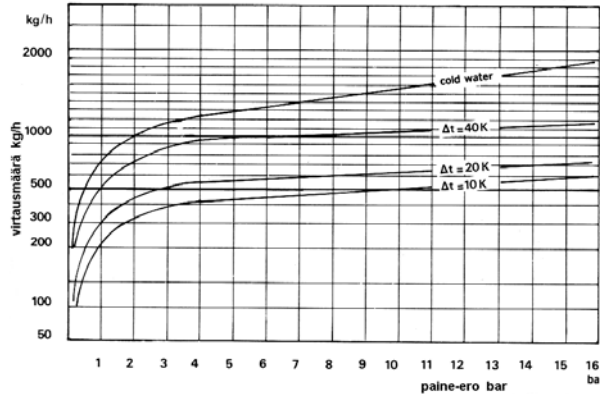

KS



KSV

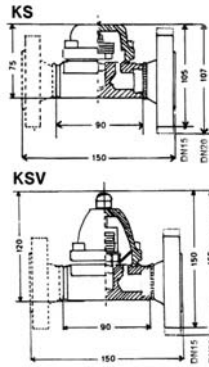
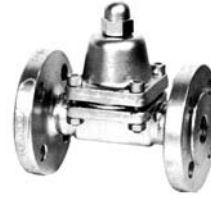

Soveltuu myös höyrylle ilman ja lauhumattomien kaasujen poistoon.

## MALLISARJA MSV kiertein ja laipoin

Käyttöpaine 0 – 26 bar / 400°C  
Maks. paine-ero 23 bar  
Teräs GSC-25 / RST-osat

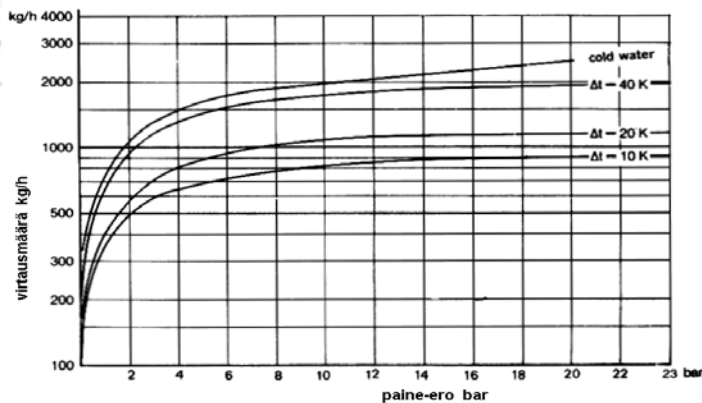

kiertein



laipoin

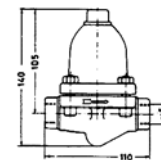

MS

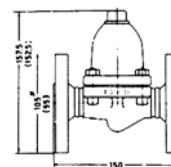

MSV

## MALLISARJA A, AG, AS, AGS

Malli A DN20 PN16 0 – 15 bar / 220°C  
Malli AG DN50 PN16 0 – 15 bar / 220°C

Malli AS DN20 PN40 0 – 25 bar / 400°C  
Malli AGS DN50 PN40 0 – 25 bar / 400°C

Pyydä erikoisesite.

### MONITOIMIPOISTIN

Lauhteenpoisto + takaiskuventtiili +  
näkölasi + säädettävyys + suodin

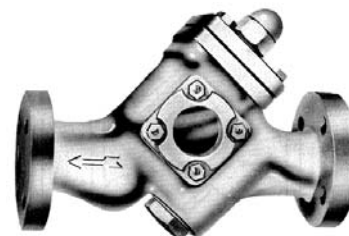

Vain silmäys niin näette mitä putkistossa tapahtuu. Poistin on säädettävissä.

## MALLISARJA FLT-17

DN40 – DN50 PN16  
 FLT 17-4,5 DN40-50 198°C  
 FLT 17-10 DN40-50 198°C  
 FLT 17-14 DN40-50 198°C

Pesä ja kansi GGG40  
 Sisäosat AISI-304/410  
 Suunn. 16 bar / 250°C

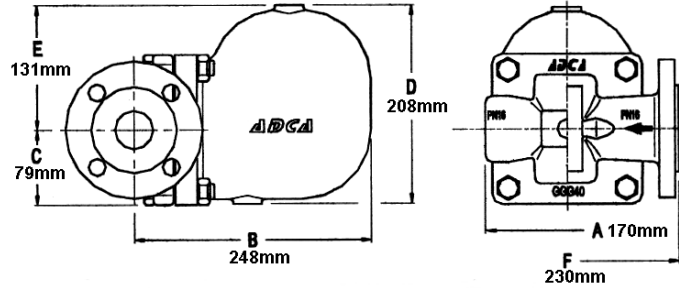
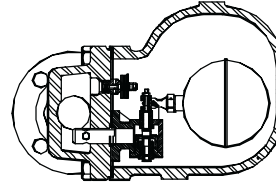

VIRTAUSMÄÄRÄ Kg/h

MALLI	KOKO	PAINERO (bar)											
		0,1	0,3	0,5	0,7	1	1,5	2	4,5	7	10	12	14
FLT17-4,5	40-50	1100	1800	2400	2800	3400	3900	4500	7300				
FLT17-10	40-50	650	1200	1500	1750	2000	2600	3000	4000	5400	6200		
FLT17-14	40-50	450	750	950	1100	1300	1600	1800	2600	3250	3900	4210	4950

## MALLISARJA FLT-32

DN15 – 20 – 25 PN40  
 kiertein 1/2", 3/4"

FLT 32 – 4,5  
 FLT 32 – 10  
 FLT 32 – 14  
 FLT 32 – 21

Pesä-kansi teräs GSC-25  
 Sisäosat AISI-304/410  
 Maks. 32 bar / 250 °C  
 Suunn. 40 bar / 400 °C

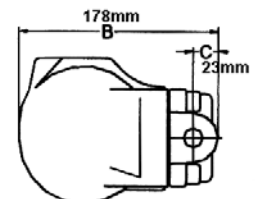
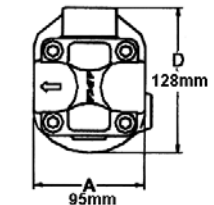
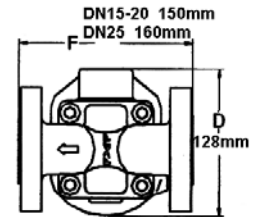
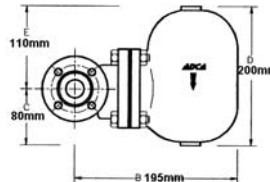
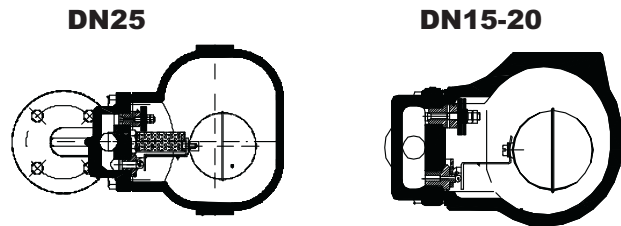

VIRTAUSMÄÄRÄ Kg/h

MALLI	KOKO	PAINERO (bar)														
		0,5	1	1,5	2	3	4,5	6	7	8	9	10	12	14	16	21
FLT32-4,5	1/2"-1"	230	330	400	440	535	630									
FLT32-10	1/2"-1"	150	200	250	280	340	400	460	495	520	550	595				
FLT32-14	1/2"-1"	120	150	190	220	260	320	380	400	425	440	480	510	550		
FLT32-21	1/2"-1"	60	80	90	115	135	160	190	200	220	230	240	260	270	290	300

FLT-32HC SUURTEHO VIRTAUSMÄÄRÄ Kg/h

MALLI	KOKO	PAINERO (bar)														
		0,5	1	1,5	2	3	4,5	6	7	8	9	10	12	14	16	21
FLT32-4,5	1"	900	1250	1450	1700	2010	2400									
FLT32-10	1"	450	620	790	880	1100	1250	1500	1600	1700	1750	1800				
FLT32-14	1"	340	435	530	600	610	850	990	1100	1190	1240	1300	1350	1380		
FLT32-21	1"	230	330	400	440	535	630	720	800	840	900	920	1020	1120	1260	1270

## MALLISARJA FLT-17

FLT 17 - 4,5 BAR / 198°C  
 FLT 17 - 10 BAR / 198°C  
 FLT 17 - 14 BAR / 198°C

Kiertein 1/2", 3/4" PN16  
 Laipoin DN15, DN20 PN16  
 Suunn. 16 bar / 250°C

Pesä teräs GSC-25  
 Kansi GGG40.3  
 Sisäosat AISI-304/410

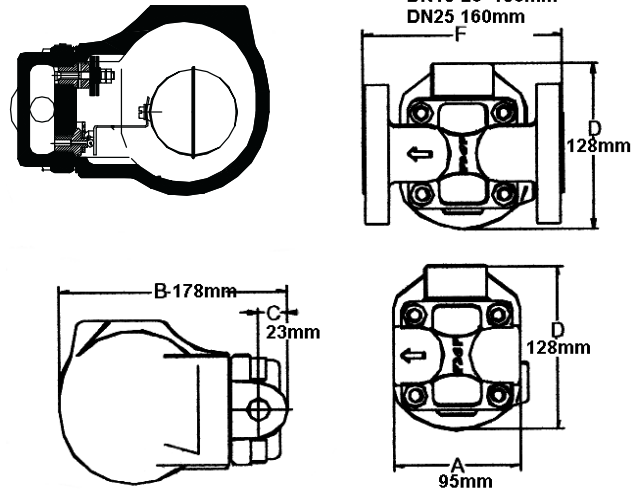

VIRTAUSMÄÄRÄ Kg/h

MALLI	KOKO	PAINE-ERO (bar)												
		0.5	1	1,5	2	3	4,5	6	7	8	9	10	12	14
FLT17-4,5	1/2"- 1"	200	280	320	360	400	495							
FLT17- 10	1/2"- 1"	110	140	175	190	230	280	300	330	350	390	405		
FLT17-14	1/2"- 1"	70	100	120	140	155	190	210	220	225	230	260	280	300

## MALLISARJA FLT-17HC SUURTEHO

FLT 17HC - 4,5 BAR / 198°C  
 FLT 17HC - 10 BAR / 198°C  
 FLT 17HC - 14 BAR / 198°C

Kiertein 1" PN16  
 Laipoin DN25 PN16

Pesä ja kansi GGG40.3  
 Sisäosat AISI-304/410  
 Suunn. 16 bar / 250°C

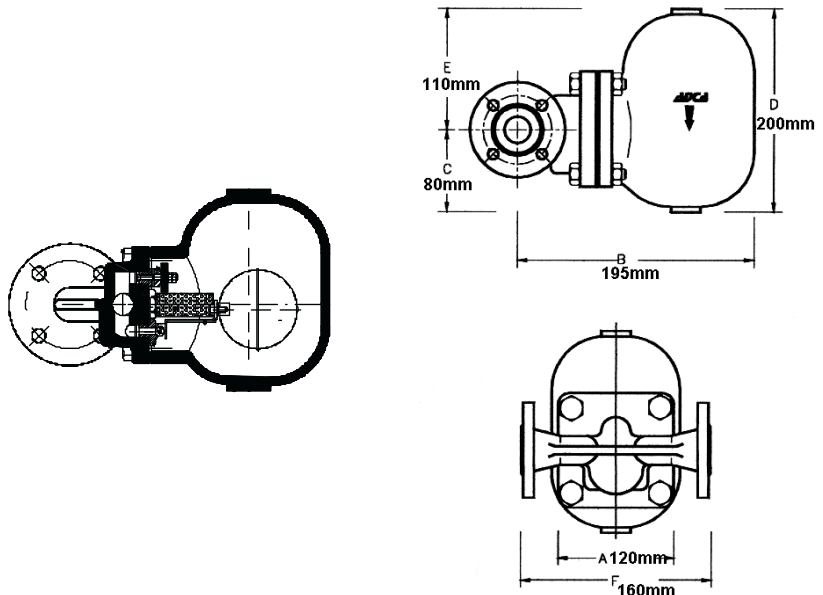

VIRTAUSMÄÄRÄ Kg/h

MALLI	KOKO	PAINE-ERO (bar)												
		0.5	1	1,5	2	3	4,5	6	7	8	9	10	12	14
FLT17HC-4,5	1"	900	1250	1450	1700	2010	2400							
FLT17HC- 10	1"	390	550	675	790	900	1000	1200	1300	1400	1500	1590		
FLT17HC-14	1"	250	350	430	500	590	680	800	850	900	950	1000	1000	1150

## MALLI VARIO 1200

DN15 – 20 – 40 – 40 – 50 PN40

Pesä ja kansi GGG40.3 tai

Pesä ja kansi GSC-25

tai AISI-316 DN15 – 20 – 25

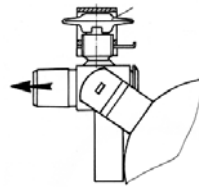
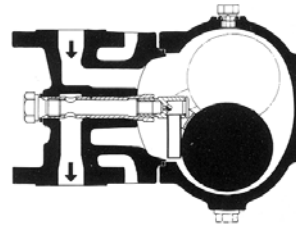

Vario-SO



Vario-SU



Vario-WR



Vario-WL

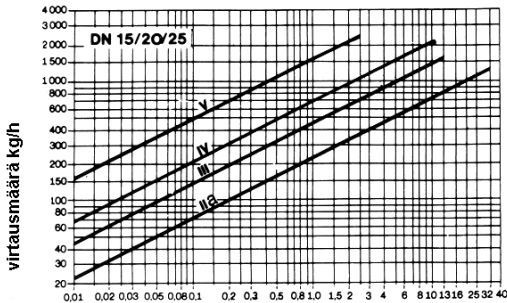

▶ paine-ero bar

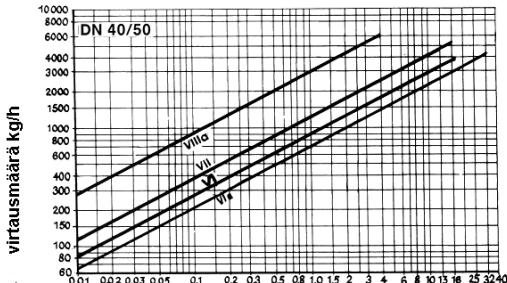

▶ paine-ero bar

varusteena uimurikoneisto	maks. bar höyrynpaine	maks. bar ilmanpaine
II a	32	40
III	13	15
IV	11	14
V	2,5	3
VI	17	24
Via	32	32
VII	16	24
VIII a	4	5

## SUURTEHOMALLIT

WO-1030 DN80-100 suora

EF-1018 DN80-100 kulma

Teräs P265GH(HII)

7,5 bar / 400°C, 10 bar / 300°C

13 bar / 200°C, 16 bar / 100°C

Pyydä yksityiskohtainen esite.

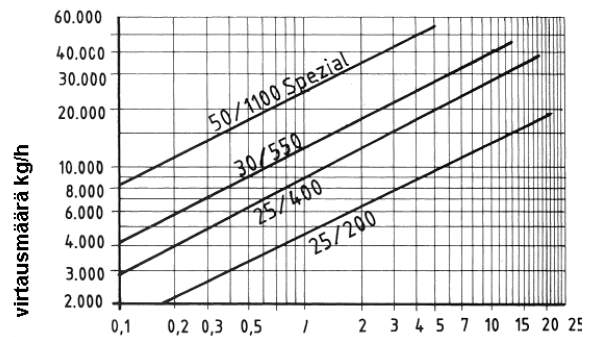
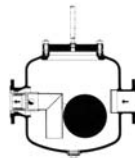

▶ paine-ero bar

## KORKEAPAINEMALLIT

PN63, PN100, PN160

DN15 – 50

Teräs, 13CrMo44, ss 1.4571

Pyydä yksityiskohtainen esite.

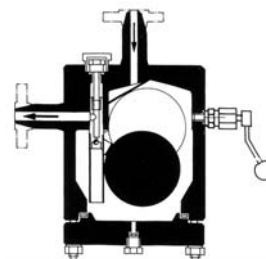
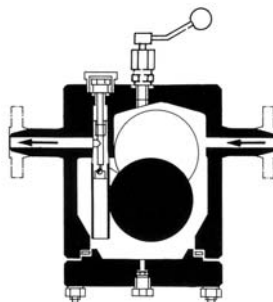
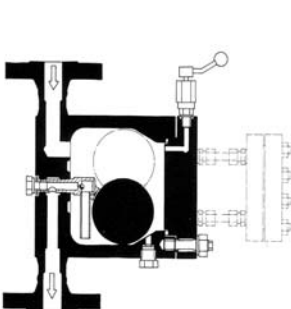

### MALLI S1000

DN15 – 20 – 25 PN25  
 Pesä ja kansi GGG40  
 16 bar / 300°C, 13 bar / 350°C

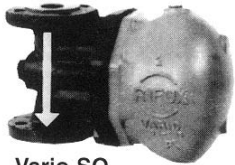
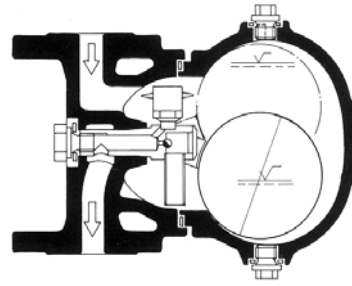

Vario-SO



Vario-SU



Vario-WR



Vario-WL

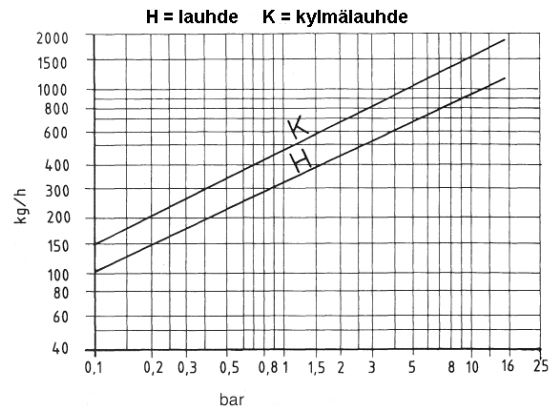

### MALLI S1100

DN 15 – 20 – 25 – 40 – 50 PN25  
 Pesä ja kansi GGG40  
 16 bar / 300°C, 18 bar / 250°C, 25 bar / 100°C

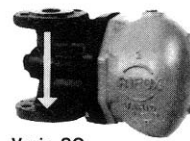
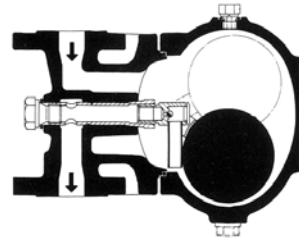

Vario-SO



Vario-SU

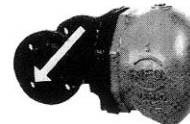

Vario-WR



Vario-WL

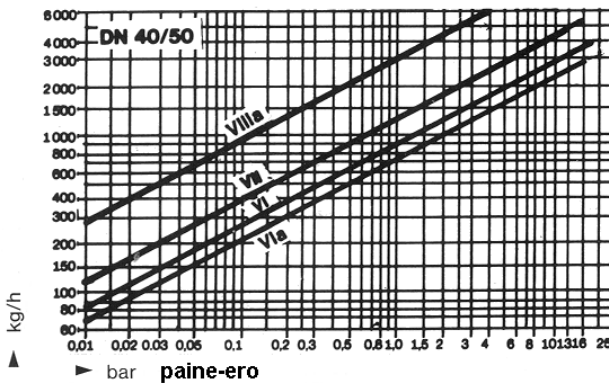
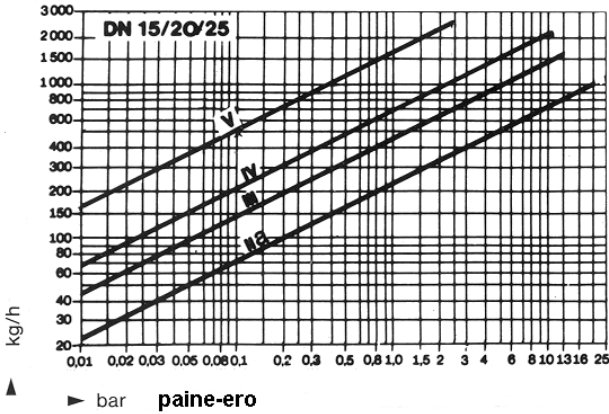

Varusteena uimurikoneisto	max. bar höyrynpaine	max. bar ilmanpaine
II a	20	25
III	13	15
IV	11	14
V	2,5	3
VI	17	24
VI a	20	25
VII	16	23
VIII a	4	5

Soveltuu myös vedenpoistimeksi paineilmalle.

## MALLISARJA DT42S PN40

Pesä teräs C22.8 1/2" – 3/4" – 1"  
 Kansi-sulkupinta AISI-431 DN15 – 20 – 25  
 Suodin AISI-304  
 Käyttöpaine 42 bar / 400°C  
 Suunn.paine 63 bar / 400°C  
 Käyttöalue 0,25 – 42 ba

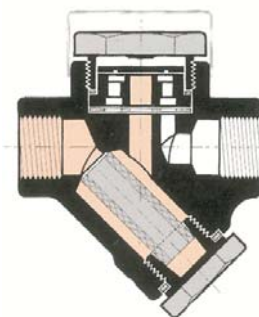

MITAT (mm)							
KIERTEIN				LAIPOIN			
KOKO	A	B	C	D	PAINO	E	PAINO
DN					Kg	Kg	
1/2"	80	56	46	96	1	150	2.5
3/4"	80	58	52	105	1,2	150	3.3
1"	100	65	62	115	1,8	160	4,4

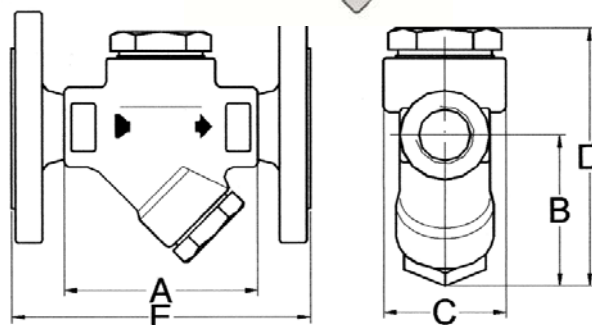

MALLI	KOKO	VIRTAUSMÄÄRÄ Kg/h												
		PAINE-ERO (bar)												
		0.5	1	3	6	9	12	15	18	21	24	30	35	42
DT42 S	1/2"	200	210	350	480	580	660	740	800	850	910	1020	1100	1200
DT42 S	3/4"	310	320	520	720	860	980	1050	1175	1220	1350	1500	1600	1750
DT42 S	1"	470	485	800	1100	1310	1500	1750	1800	1950	2100	2300	2480	2720

## MALLISARJA DT40 PN40

Pesä AISI-420/304  
 Käyttöpaine 40 bar / 350°C  
 Suunn.paine 63 bar / 400°C  
 Käyttöalue 0,25 – 40 bar

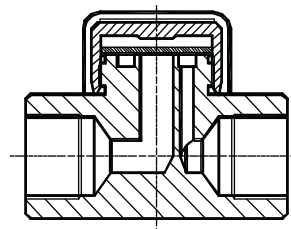

MITAT (mm)						
KOKO	A	B	C	D	E	PAINO
DN						Kg
3/8"	70	15	36	48	38	0,58
1/2"	70	15	41	52	38	0,61
3/4"	80	19	41	60	46	0,9
1"	83	25	55	77	48	1,3

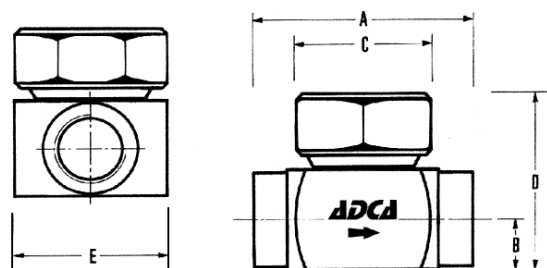

MALLI	KOKO	VIRTAUSMÄÄRÄ Kg/h												
		PAINE-ERO (bar)												
		0.5	1	3	6	9	12	15	18	21	24	30	35	40
DT40	3/8"	80	85	115	150	190	210	250	300	310	350	420	490	510
DT40	1/2"	140	170	250	330	400	490	500	580	605	690	720	800	820
DT40	3/4"	190	225	345	480	590	700	750	810	900	990	1100	1300	1390
DT40	1"	290	350	500	700	830	995	1200	1290	1320	1500	1750	1800	1995